

- 車両の連結・切りはなしについて
- How to couple and uncouple cars
- Comment atteler et dételer la rame

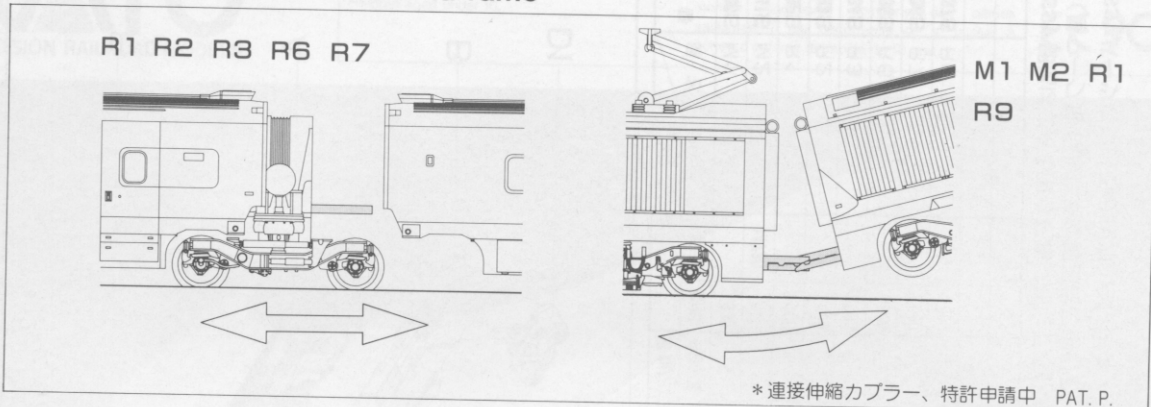

■ 模型仕様

- 全長(8両基本セット) 1060mm ● 標準消費電流DC12V時0.3A ● 最小通過曲線半径R249 ● 最大通過勾配4%

■ Specifications

- Full Length (8 car set) : 1060mm (41 1/3") ● Volt : 0 ~ 12V (DC) ● Ampere : 0.3A (12V)
- Minimum radius : R249 (9 3/4") ● Maximum incline : 4 %

■ Spécifications

- Longueur totale (coffret de 8 véhicules) : 1060mm (41 1/3")
- Tension : 0 ~ 12 volts courant continu ● Ampérage : 0.3A (sous 12 volts)
- Rayon minimal d'inscription : R249 (9 3/4") ● Pente maximale d'utilisation : 4 %

nant 8 véhicules

Set
mentaire comprenant 4 voitures

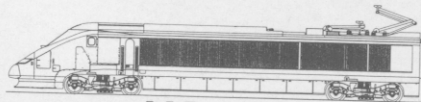

M1 (14730S)

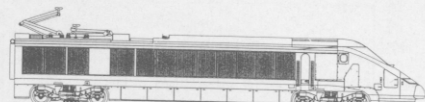

M2 (14731S)



R1 (14732S)

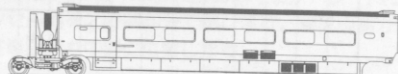

R2 (14733S)

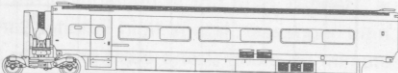

R3 (14734S)

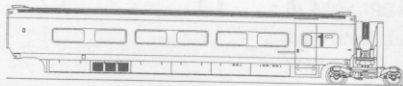

R7 (14736S)

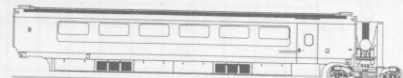

R6 (14735S)

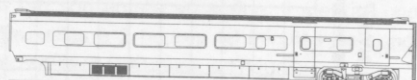

R9 (14737S)

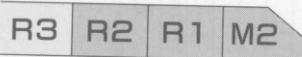

■ Légende des symboles : ☞ Eclairage avant et arrière ☞ La motrice